

Living up to Life

Leica
MICROSYSTEMS

A Shift of Perspective

DMi8

As Universal as Your Ideas
As Individual as Your Tasks

Leica DMI8 Inverted Microscope Platform





Researchers know that a shift of perspective often leads to the most exciting insights. So do we. The Leica DMI8 is the reinvention of inverted microscopy. It is as universal as your ideas, and as individual as your tasks. Find out how a shift to Leica DMI8 will inspire your work.

One platform to match the future of life sciences

From basic microscopy to high-end imaging – Leica DMI8 grows with your ever-changing needs.

Infinity Port designed for flexibility

From observation to interaction – Leica DMI8 opens new dimensions for your research.

The solution for live cell experiments

From easy handling to sophisticated analysis – Leica DMI8 and LAS X software team up perfectly with your living samples.

“Life sciences are constantly evolving. At Leica Microsystems, we have created a unique platform that grows with researchers’ needs. The Leica DMI8 tailor-made solutions leave preconfigured microscopes in the past.”

Julian Burke PhD
Chief Scientific Officer, Leica Microsystems

Enjoy the Freedom of Configuration – Be Prepared for a Bright Future

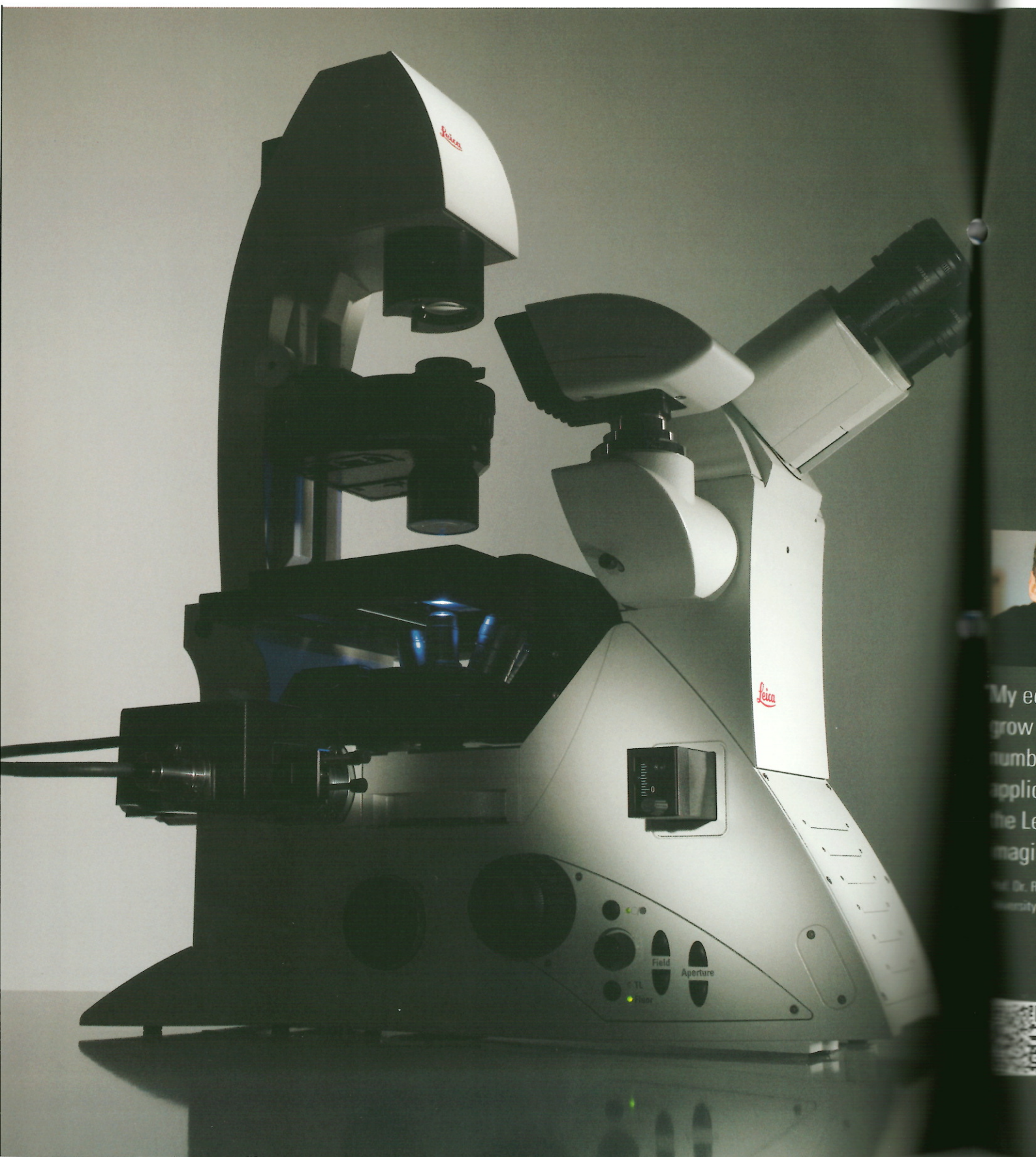

My e
grow
numb
applic
the Le
magi

Prof. Dr. F
University



No matter what type of samples you work with, no matter where your research is headed – Leica DMI8 will be there to assist you: ready to grow, ready to change, ready for brilliant results.



EASY ON YOUR BUDGET – EASILY UPGRADEABLE

The Leica DMI8 takes you beyond configuration restrictions. With the freedom of a completely modular system, you can create the perfect system for your research. For 3D images, you can integrate a motorized focus into a manual system. Or if you want multi-color images, start with a motorized filter wheel and manual focus. With hundreds of possible combinations, you can create the best solution for your work.

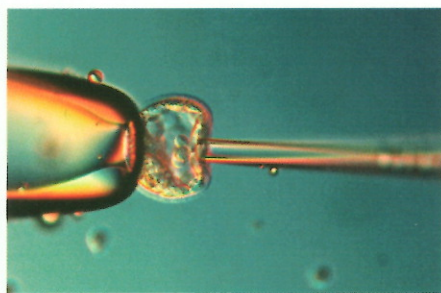

Blastocyst injection.
Courtesy of IGBMC, Strasbourg, France

MICRO-MANIPULATION SOLUTIONS

Extend your capabilities. The Leica DMI8 works with systems from Eppendorf, Narishige, Leica Microsystems, and others.

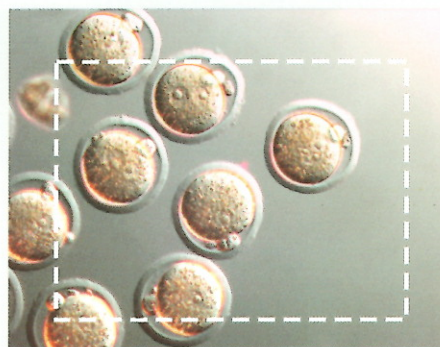

Comparison of 19 mm FOV with standard 16 mm camera ports (dotted line).
Courtesy of IGBMC, Strasbourg, France

FANTASTIC OPTICAL QUALITY OPTIMIZED FOR sCMOS CAMERAS

Do you want to see more of your sample with the highest possible resolution? We enlarged the field of view (FOV) for all camera ports. Optimized for state-of-the-art sCMOS cameras, the Leica DMI8 has 19 mm FOV. The full range of contrast techniques is available: from Brightfield, Integrated Modulation Contrast, and Phase Contrast to Darkfield, Differential Interference Contrast (DIC), and Fluorescence. With the highest quality imaging options, see your sample at its best.



Leica LAS X software, Easy Operation Mode

INTUITIVE OPERATION

The Leica DMI8 and LAS X are designed to support you. All interfaces are easy to navigate, giving you better results in a shorter time than ever before.



“My equipment needs to grow with the increasing number of demanding applications – just like the Leica Microsystems imaging solution.”

Prof. Dr. Ralf Jacob
University of Marburg, Germany



The whole story
of Leica DMI8

Discover the Infinite Manifestations of Life – Unfold the Story of Your Cells



The Leica DMI8's new core element, the Infinity Port, is the answer to the dynamic nature of science. It provides access to a wide range of functions for direct interaction with your sample – meeting the trends in life sciences.

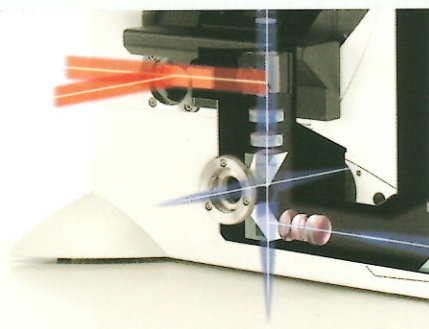

The new Infinity Port (shown in red)

THE INNOVATIVE INFINITY PORT

Open to even more possibilities, the Leica DMI8 features an additional incident illumination port. The Infinity Port provides unmatched flexibility along with the highest optical performance.

This novel design facilitates the integration of additional fluorescence light sources and laser systems for advanced applications like FRAP, photo-switching, ablation, optogenetics, tweezing, and many more.

CALCIUM IMAGING

The Leica DMI8 offers a dedicated system for FURA2 imaging. New objectives combine high NA and UV transmission of up to 60% at 340 nm. Along with extremely fast external filter wheels (24 ms switching time) the system is perfectly equipped for capturing fast dynamic processes like calcium measurements.

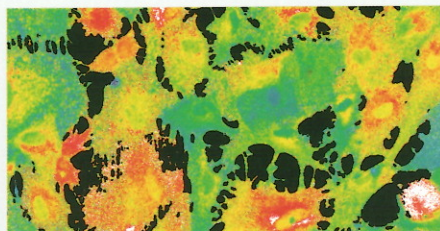

Courtesy of Drs. Kazunori Kanemaru and Masamitsu Iino, The University of Tokyo, Japan



20 nm precision for a 12 mm travel range

NEW LEICA DMI8 FOCUS DRIVE

The Leica DMI8 features a new Closed Loop Focus with 20 nm positional accuracy. Combined with an increased travel range of 12 mm, the Leica DMI8 offers high precision 3D image reconstruction of large tissues and complete organisms. Get high quality data with unprecedented accuracy with this innovation.

ULTIMATE HIGH-SPEED IMAGING

To understand dynamic processes in live cells, multidimensional data must be captured at the speed of life.

Control all processes simultaneously with the Leica DMI8 sequencer. Integrate light sources and state-of-the-art sCMOS cameras with μ s speed and accuracy. Add light sources like the Lumen Dynamics X-LED or Lumencor SpectraX and cameras from Andor, PCO, Hamamatsu, and others for unmatched imaging performance. For simultaneous multi-channel image acquisition, use the Dual-View Image Splitter. With so many possibilities find the best solution for your high speed application, all integrated in LAS X software.



Leica DMI8
applications

Create Your Own Live Cell Environment – See What Lies Ahead



"Leica products are perfectly tuned to each other – and can be configured for a wide variety of investigations."

Dr. Jean-Luc Vonesch
IGBMC Strasbourg, France

The Leica DMI8's infinite capacity for seamless integration makes it easy to control the parameters of your live cell experiments. Obtain highly reproducible data to gain deeper insight into life.

PLEASANT ENVIRONMENT

Keeping cells happy is the most challenging and important task in live cell experiments. With Leica DMI8, all environmental parameters are controlled via LAS X and are linked to the image acquisition. Unique features, such as "start experiment when the right environmental conditions are reached," eliminate the occurrence of artifacts.

INTUITIVE AND VERSATILE SOFTWARE

The new LAS X combines the most powerful microscope software features available today in one package, yet maintains usability in all aspects of the interface, functions and workflow.

- Dedicated acquisition and hardware implementation
- Analysis of multi-dimensional data sets
- Advanced environmental control



Monitor your experiment anywhere at any time with Mobile Connection from Leica Microsystems

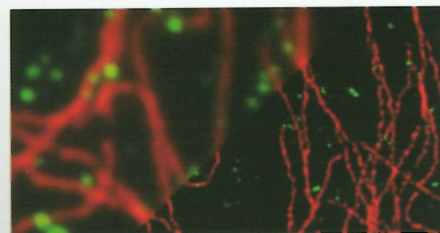

Leica DMI8: platform for leading super resolution systems like GSD 3D and STED 3D.
Courtesy of S. Hell, Max-Planck-Institut for Biophysical Chemistry, Göttingen, Germany

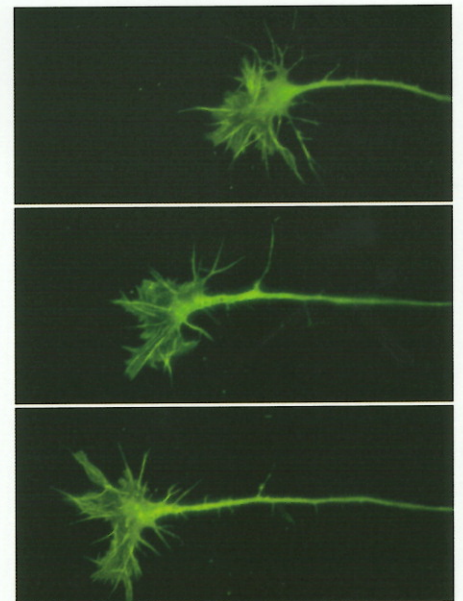

Chick DRG neuron (green: Actin, YFP).
Courtesy of Kazumasa Ohashi, Tohoku University, Japan

NEVER FOCUS AGAIN

Save time searching for your cells and eliminate photo-toxicity from fluorescent light during focusing. Strong temperature shifts, long distance stage movements: your image remains constant.

One click of a button and the LED light beam assisted Leica Adaptive Focus Control (AFC) automatically maintains your focus, in real time.

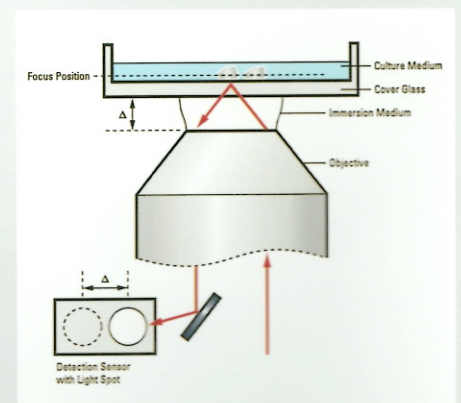

Build on the Open Microscope Platform – Adapt it to Your Science

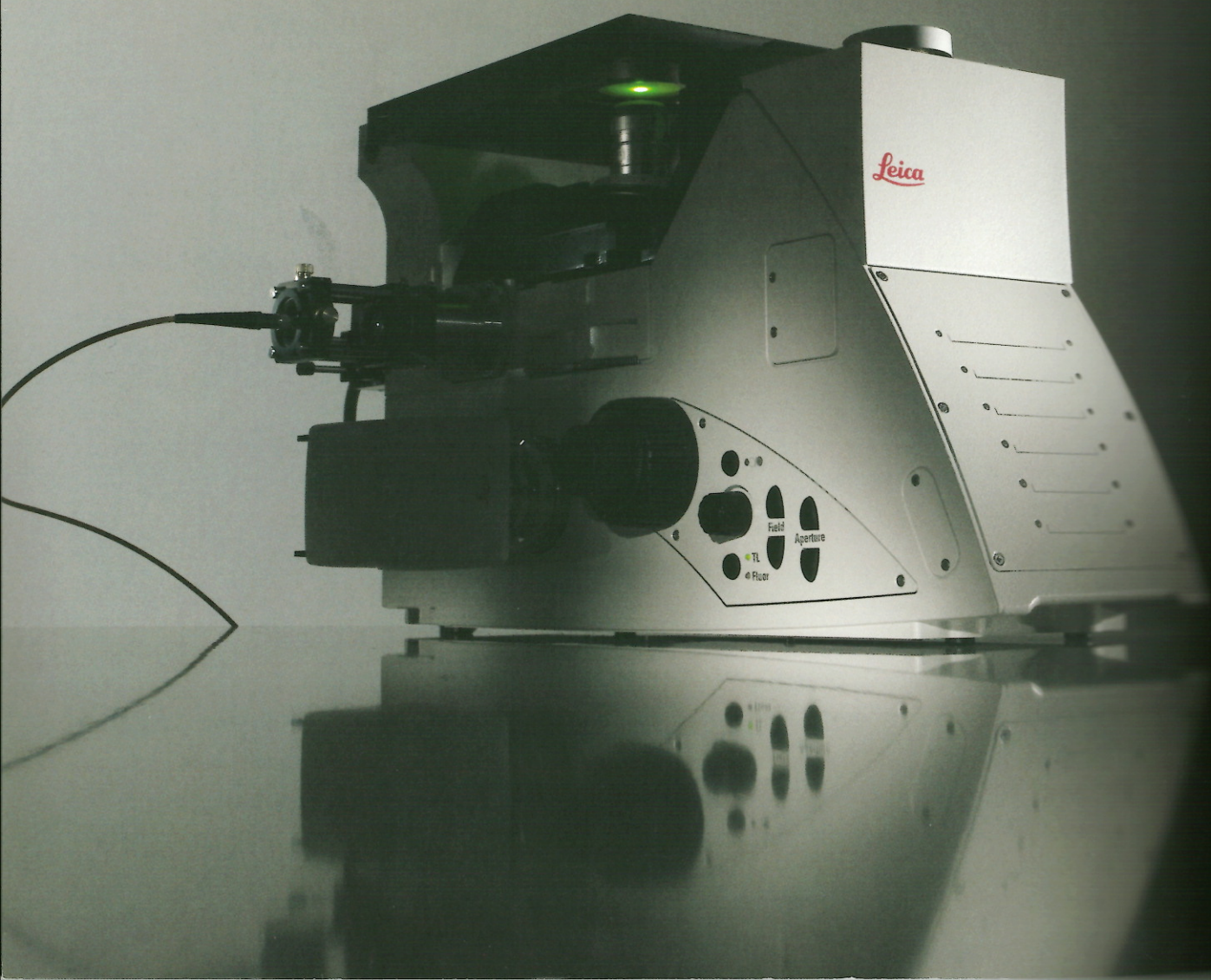

To bre
it's go
partne
The Data
the Pa
Mathema
Strateg
one of the
2014 Nobel

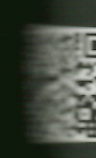

Maximum flexibility, functionality and innovation are the top priority for your research. Leica Microsystems partners with industry-leading companies, and with you.



"To break a barrier, it's good to have a partner like Leica."

Prof. Stefan Hell
Max Planck Institute for
Biophysical Chemistry,
Göttingen, Germany,
one of the winners of the
2014 Nobel Prize in Chemistry

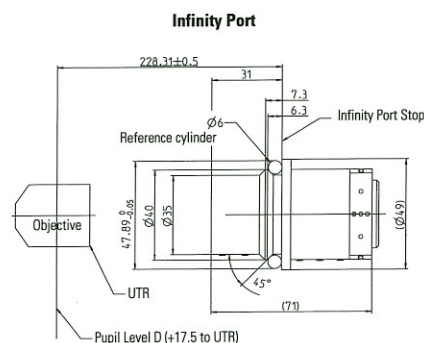
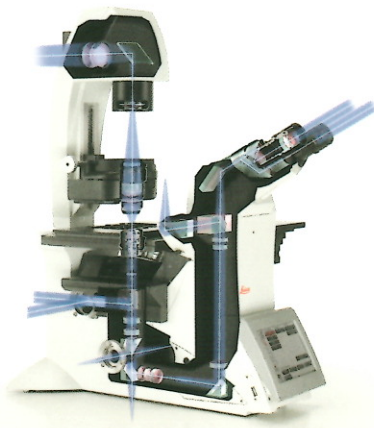

Opto-mechanical documentation of the Infinity Port

CREATE YOUR OWN LEICA DMI8

The Leica DMI8 and LAS X are designed for seamless integration of external devices. Leica Microsystems invites you to create your own version of the Leica DMI8. The Infinity Port Connector, along with complete optomechanical design documentation, opens the light path to any accessory you want to add.

Attach Thorlabs Cage Systems or Linos Microbench or Nanobench components directly to the Leica DMI8 by simply adding them to the Infinity Port Connector. For special applications, use 3rd party software such as Metamorph (Molecular Devices).



As a high-performance solutions provider, the Systems Division at Andor has found the Leica DMI8 to be a perfect match with its unique open port concept, optical quality, and robustness. Andor has fully integrated the DMI8 into its product range, validating optical, mechanical, and software compatibility.

Dr. Mark Browne, Director, Systems Division,
Andor Technology

CONTINUITY IN QUALITY

The Leica DMI8 is designed and manufactured with the quality you expect from Leica Microsystems. Brilliant optics, high-grade materials, robust design, ease of use down to the smallest details, and customer-centered service deliver unmatched performance.



Check out
Leica DMI8
hardware
components

The statement by Ernst Leitz in 1907, "With the user, for the user," describes the fruitful collaboration with end users and driving force of innovation at Leica Microsystems. We have developed five brand values to live up to this tradition: Pioneering, High-end Quality, Team Spirit, Dedication to Science, and Continuous Improvement. For us, living up to these values means: **Living up to Life.**

LIFE SCIENCE DIVISION

The Leica Microsystems Life Science Division supports the imaging needs of the scientific community with advanced innovation and technical expertise for the visualization, measurement, and analysis of microstructures. Our strong focus on understanding scientific applications puts Leica Microsystems' customers at the leading edge of science.

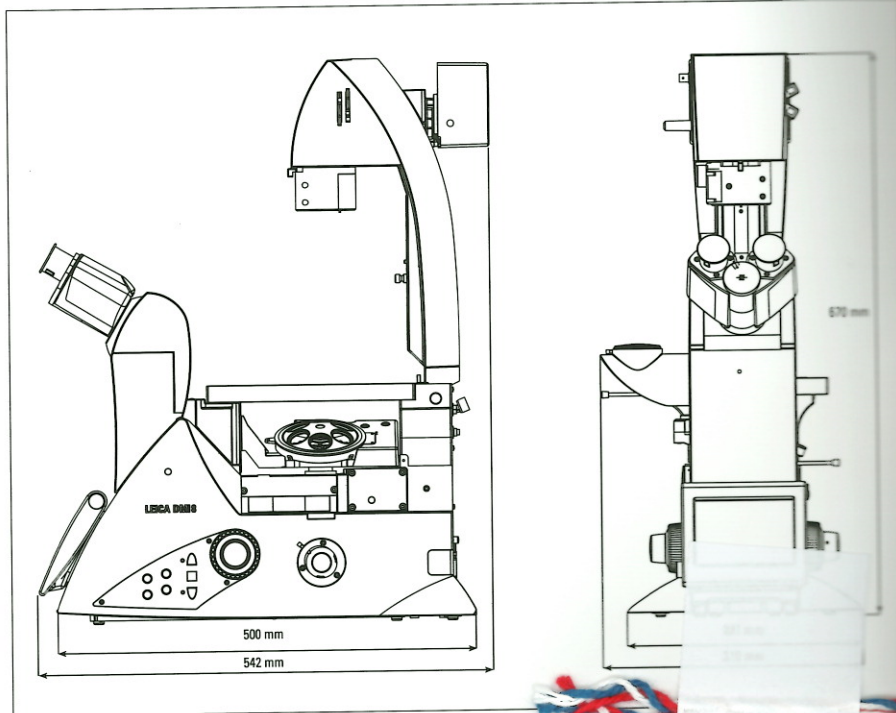

Leica Microsystems – an international company with a strong network of worldwide customer services:

Active worldwide	Tel.	Fax
Australia - North Ryde	+6 2 8870 3500	2 9878 1055
Austria - Vienna	+43 1 486 80 50 0	1 486 80 50 30
Belgium - Diegem	+32 2 790 98 50	2 790 98 68
Canada - Concord/Ontario	+1 800 248 0123	847 236 3009
Denmark - Ballerup	+45 4454 0101	4454 0111
France - Nanterre Cedex	+33 811 000 664	1 56 05 23 23
Germany - Wetzlar	+49 64 41 29 40 00	64 41 29 41 55
Italy - Milan	+39 02 574 861	02 574 03282
Japan - Tokyo	+81 3 5421 2800	3 5421 2896
Korea - Seoul	+82 2 514 65 43	2 514 65 48
Netherlands - Rijswijk	+31 70 4132 100	70 4132 109
People's Rep. of China - Hong Kong	+852 2564 6699	2564 4163
People's Rep. of China - Shanghai	+86 21 6039 6000	21 6387 8888
Portugal - Lisbon	+351 21 388 9112	21 385 4668
Singapore	+65 6550 5992	6564 5955
Spain - Barcelona	+34 93 494 95 30	93 494 95 30
Sweden - Kista	+46 8 625 45 45	8 625 45 45
Switzerland - Heerbrugg	+41 71 726 34 34	71 726 34 34
United Kingdom - Milton Keynes	+44 800 298 2344	1908 2362
USA - Buffalo Grove/Illinois	+1 800 248 0123	847 388 5500

